

Senest revideret:
Last update:
Letzte Änderung:
Senast ändrad:
Muutettu viimeksi:
Laatst herzien
Dernière mise à jour
18.03.2019

DK: Bemærk:
Komposit stolper skal ALTID forbores - se side 11+12.

UK: Note:
Composite poles must ALWAYS be predrilled - see page 11+12.

DE: Beachten:
WPC-Pfosten müssen IMMER vorgebohrt werden - siehe Seite 11+12.

S: OBS:
Komposit stolpar måste ALLTID förborras - se sida 11+12.

FIN: Huom:
Komposiittolppia on AINA porattava - katso sivu 11+12.

NL: Note:
Composiet palen moeten ALTIJD voorgeboord worden
- zie bladzijde 11+12.

F: Note:
Les poteaux composites DOIVENT toujours être pré-percés
- voir page 11+12.

N: Note:
Komposittstenger må ALTID bores - se side 11+12.

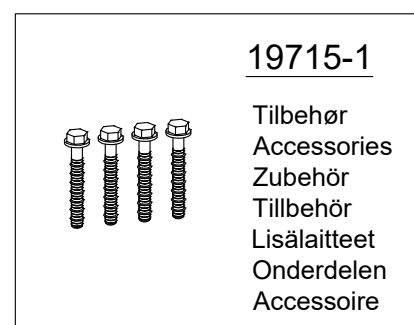
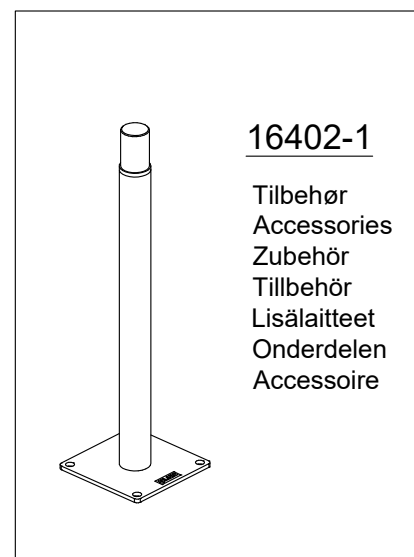
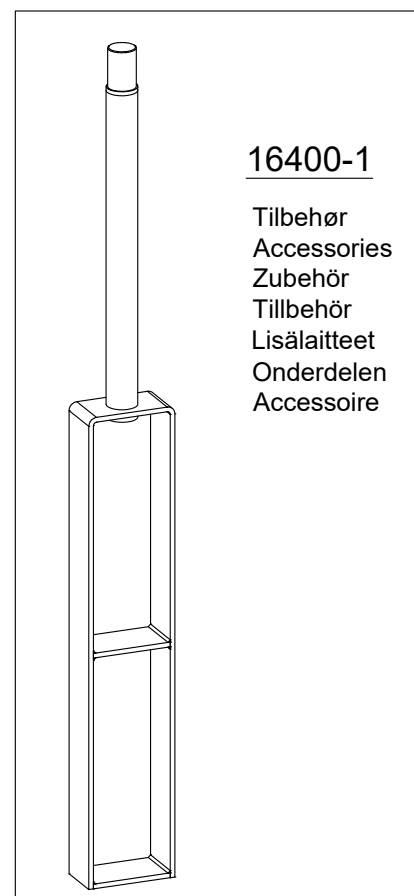

16400-1

A

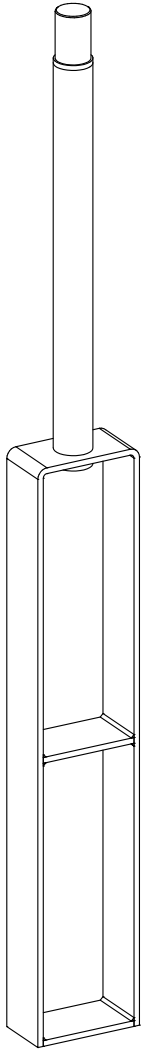

Se side 3 - 9
See pages 3 - 9
Siehe Seiten 3 - 9
Se sida 3 - 9
Katso sivu 3 - 9
Zie bladzijde 3 - 9
Voir pages 3 - 9

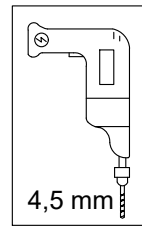

4,5 mm

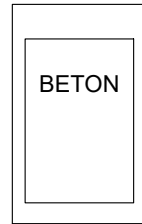
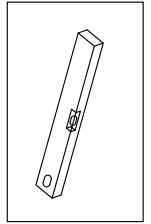
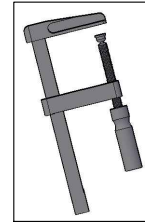
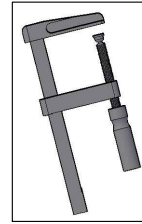
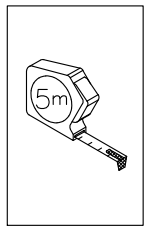
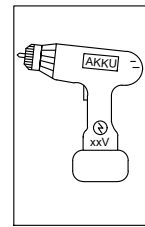

BETON

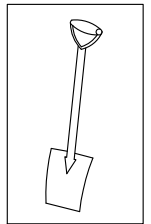
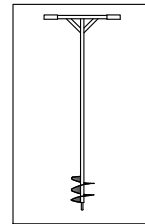

16402-1

B

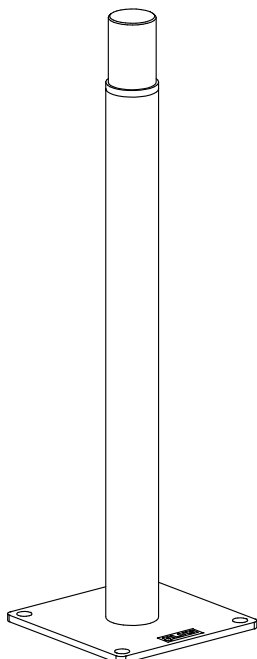

Se side 10
See pages 10
Siehe Seiten 10
Se sida 10
Katso sivu 10
Zie bladzijde 10
Voir pages 10

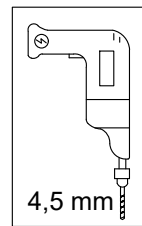

4,5 mm

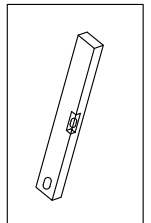
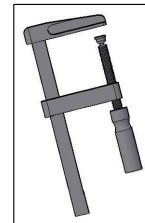
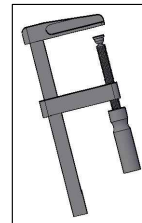
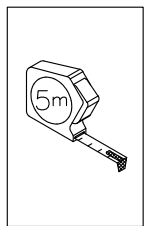
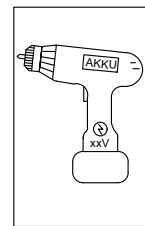

19715-1

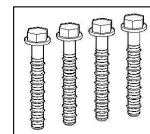

+



DK: Der må IKKE bores ekstra huller i stolpen...!

UK: Do NOT make extra holes in the post...!

DE: Bitte machen Sie KEINE zusätzlichen Löcher in der Pfosten...!

S: Det får INTE göras extra hål i stolpan...!

FIN: Älä poraa lisäreikää...!

NL: GEEN extra gaten in de post...!

F: NE PAS percer des trous supplémentaires...!

N: Ingen ekstra hull må bores i stolpen...!

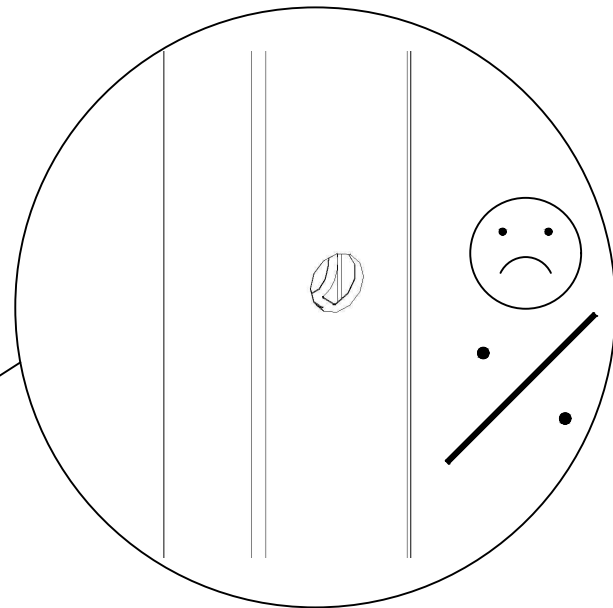

A

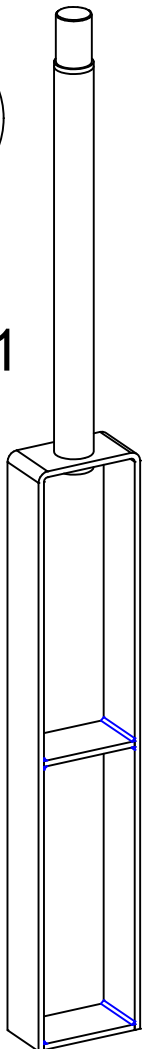

16400-1

1



2



DK: Vi anbefaler at stolpe og fod samles inden nedstøbning, stolpe og foden sættes helt sammen.

UK: We recommend that post and base are joined before casting, the post and base are fully fastened.

DE: Wir empfehlen, den Pfosten und den Pfostenträger vor dem Gießen zu montieren, der Pfosten und der Pfostenträger werden vollständig zusammengebaut.

S: Vi rekommenderar att plinten och foten monteras före gjutning, plinten och foten monteras helt.

FIN: Suosittelemme, että tolppa ja jalka kootaan ennen valua, tolppa ja jalka liitetään täysin yhteen.

NL: We raden aan om paal en voet te monteren voordat ze worden ingegoten, de paal en voet moeten volledig worden geassembleerd.

F: Nous vous recommandons de fixer le poteau et la base avant le coulage, Le poteau et la base sont parfaitement solidaires.

N: Vi anbefaler at stolpen og foten settes sammen før nedstøping, stolpen og foten settes helt sammen.

- DK: Skruen monteres i modsat side af hvor hegnet skal monteres, eller fjernes igen før monteringen af hegnet.
- UK: The screw is mounted opposite to where the fence is to be mounted or removed again before mounting the fence.
- DE: Montieren Sie die Schraube gegenüber der Stelle, an der der Zaun montiert oder entfernt werden soll, bevor Sie den Zaun montieren.
- S: Skruven monteras i motsatt sida av där staketet ska monteras eller avlägsnas innan du monterar staketet.
- FIN: Ruuvi kiinnitetään aidan kiinnittämiseen nähden vastakkaiselle puolelle tai irrotetaan ennen aidan asennusta.
- NL: Monteer de schroef aan de andere kant van de plaats waar het hek moet worden gemonteerd of wordt weer verwijderd voordat u het hek monteert.
- F: La vis est positionnée en face de l'emplacement où la barrière doit être montée ou retirée à nouveau avant de monter la barrière.
- N: Skruen monteres i motsatt side av hvor gjerdet skal monteres, eller fjernes igjen før monteringen av gjerdet.

3



4

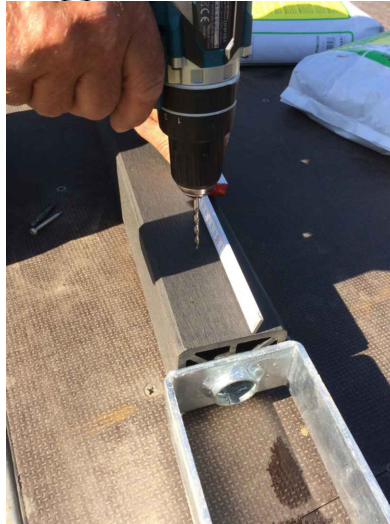

5



DK: Fastgør stolpen, forbores stille og roligt.

FIN: Kiinnitä teräs ydin ruuvilla, poraa hiljaa.

UK: Fasten the post, predrilled carefully.

NL: Bevestig de stalen kern, voorboren rustig.

DE: Befestigen Sie den Pfosten, Vorbohren vorsichtig und langsam.

F: Fixer cette pièce à l'aide d'une vis, a percer doucement.

S: Fäst plinten, förborra lugnt och försiktigt.

N: Fest stolpen, forbores stille og roligt.

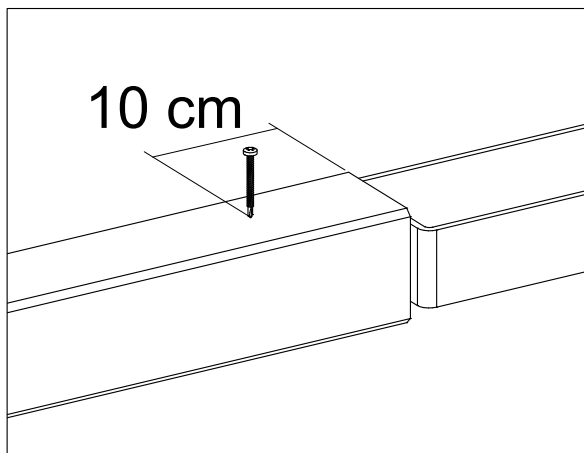
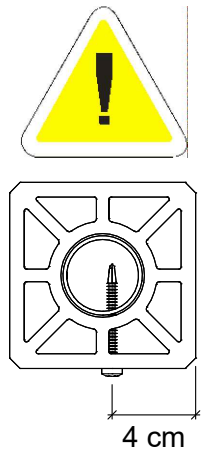

= 5,5 mm

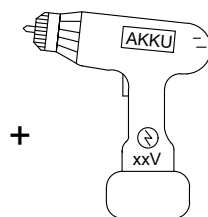
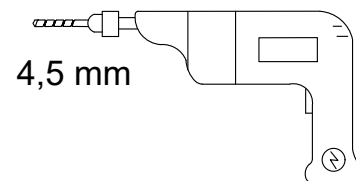

6

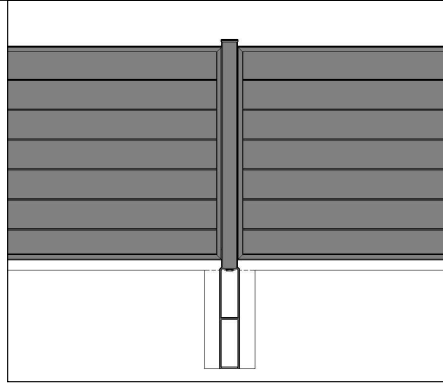

DK: Placér stolpen i hullet.
 UK: Place the post in the hole.
 DE: Positionieren Sie den Pfosten im Loch.
 S: Placera plinten i hålet.
 FIN: Tolppa asetetaan reikään.
 NL: Plaats de paal in het gat.
 F: Disposez le poteau dans le trou.
 N: Plasser stolpen i hullet.

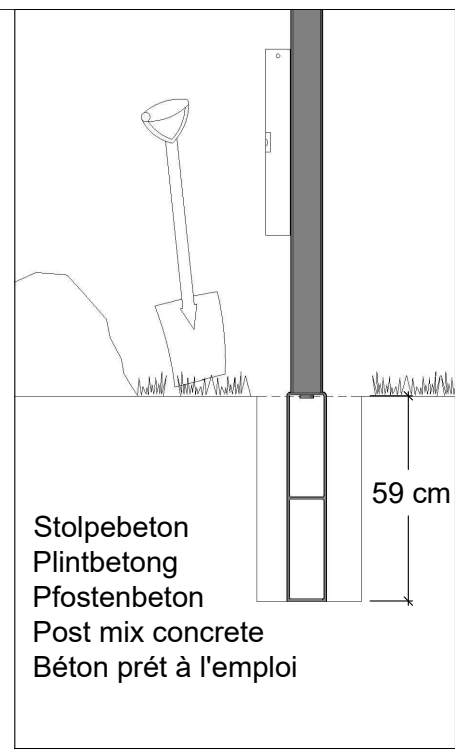

7



DK: Stolpen placeres så overkant stolpefod er ca. en centimeter over terræn.
 UK: The post is placed so that the upper edge of the post base is approx. one centimetre above ground.
 DE: Der Pfosten wird so platziert, dass die Oberkante des Pfostenträgers ca. einen Zentimeter über dem Boden ist.
 S: Plinten placeras så att fotens överkant är ca en centimeter över marken.
 FIN: Tolppa sijoitetaan siten, että tolppajalan yläreuna on noin yksi senttimetri maanpinnan yläpuolella.
 NL: De paal wordt zo geplaatst dat de bovenkant van de voet ongeveer één centimeter boven de grond uitsteekt.
 F: Le poteau est disposé de sorte que le bord supérieur de la base du poteau soit situé à env. 1 cm au-dessus du sol.
 N: Stolpen plasseres slik at overkant på stolpefoten er ca. en centimeter over bakken.

Tips - Advice - Tipps - Vihjeitä - Conseils

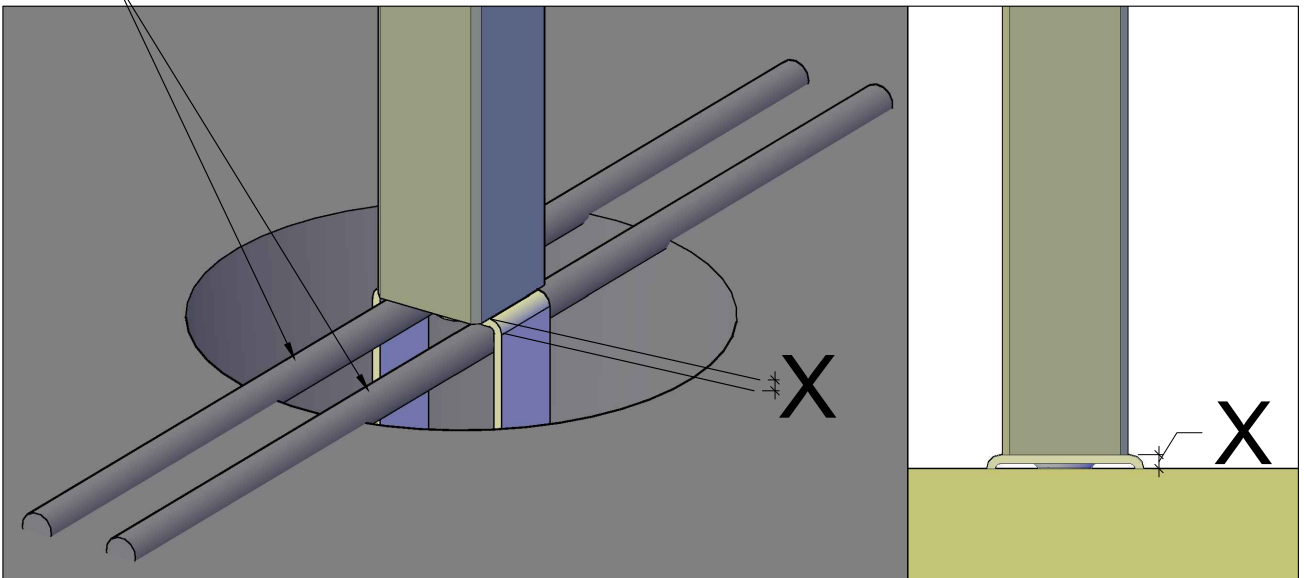

8



DK: Stolpen justeres til og støttes, inden betonen kommes i hullet.

- Se billede 8-13.

UK: The post is adjusted and supported before the concrete enters the hole. – See images 8-13.

DE: Der Pfosten wird angepasst und gestützt, bevor der Beton in das Loch gefüllt wird – siehe Bild 8-13.

S: Justera och stötta upp plinten innan betongen hälls i hålet – se bild 8–13.

FIN: Tolppa säädetään ja tuetaan, ennen kuin betoni laitetaan reikään. - Katso kuvat 8-13.

NL: De paal wordt afgesteld en ondersteund voordat het beton in het gat komt. - Zie afbeelding 8-13.

F: Le poteau est ajusté et soutenu avant de couler le béton dans le trou. - Cf images 8-13.

N: Stolpen justeres og støttes før betongen helles i hullet. - Se bilde 8-13.

9

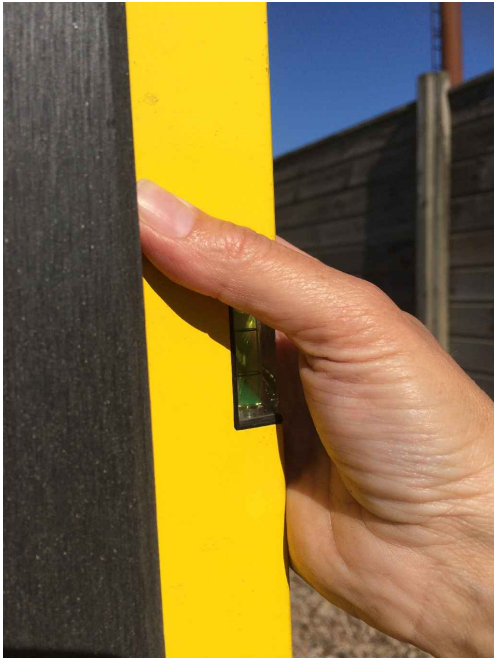

10



11



12



13



14



DK: Vi anbefaler at stolpen nedstøbes i stolpebeton/tørbeton.

UK: We recommend that the post is cast in post mix concrete/dry-cast concrete.

DE: Wir empfehlen, den Pfosten in Pfostenbeton/Trockenbeton einzugießen.

S: Vi rekommenderar att plinten gjuts i plintbetong/torrbetong.

FIN: Suosittelemme, että tolppa valetaan tolppabetoniin/kuivaan betoniin.

NL: We raden aan om de paal in palenbeton/droog beton te zetten.

F: Nous recommandons de couler le poteau dans du béton prêt à l'emploi/coulé à sec.

N: Vi anbefaler at stolpen støpes ned i betong/tørrbetong.

15



DK: Kontrollér at stolpen stadig er i vinkel, inden betonen størkner - Se billede 15-18.

UK: Make sure that the post is still at an angle before the concrete hardens – See images 15-18.

DE: Stellen Sie sicher, dass sich der Pfosten immer noch im rechten Winkel befindet, bevor der Beton trocknet – siehe Bild 15-18.

S: Se till att plinten fortfarande är i vinkel innan betongen stelnar – se figur 15–18.

FIN: Varmista, että tolppa on yhä kulmassa, ennen kuin betoni kovettuu - katso kuvat 15-18.

NL: Zorg ervoor dat de paal nog steeds waterpas staat voordat het beton droogt - Zie afbeelding 15-18.

F: Veillez à ce que le poteau garde le bon angle avant le durcissement du béton - Cf images 15-18.

N: Kontroller at stolpen fortsatt er i vinkel før betongen størkner - Se bilde 15-18.

16



Viktigt - at betonen omkring stolpefoden er hærdet op 2-3 dage, før man fortsætter med montagen af hegnet.

Important - the concrete around the post is hardened 2-3 days before continuing the fence mounting.

Wichtig - Es ist wichtig dass der Beton um den Pfosten 2 bis 3 Tage aushärtet, bevor man mit der Montage des Zaun fortfährt.

Viktigt - Betongen runt plitens fot måste härda i 2–3 dagar innan man fortsätter med monteringen av stängslet.

Tärkeää - tolppajalan ympärillä olevan betonin tulee kovettua 2-3 päivää ennen aidan asennuksen jatkamista.

Belangrijk - laat het beton rond de voet van de paal 2-3 dagen harden voor u het hek monteert.

Important que le béton autour du pied du poteau durcisse pendant 2 à 3 jours avant de procéder à l'installation de la clôture.

Viktig - at betongen rundt stolpefoten får herde i 2-3 dager før du fortsetter med å montere gjerdet.

17



18



19



20



DK: Når betonen er tør kan der lukkes til.
Dog anbefaler vi at der er lidt luft mellem stolpe og terræn.
Så fugten ikke trænger op i stolpen.

UK: When the concrete is dry, closing up can be done.
However, we recommend leaving a gap between the post
and the terrain.
That way moisture will not rise up into the post.

DE: Wenn der Beton trocken ist, kann er abgedeckt werden.
Wir empfehlen jedoch, dass sich Luft zwischen dem Pfosten
und dem Gelände befindet,
damit keine Feuchtigkeit in den Pfosten eindringt.

S: När betongen är torr kan den stängas.
Vi rekommenderar dock att det finns lite luft mellan plinten
och marken.
Så att fukten inte tränger upp i plinten.

FIN: Kun betoni on kuivaa, se voidaan sulkea.
Suosittelemme kuitenkin, että tolpan ja maan välille jää ilmaa.
Silloin kosteus ei pääse tolppaan.

NL: Als het beton droog is, kan het worden afgedicht.
We raden echter aan om wat lucht tussen de paal en de
grond te houden.
Dan dringt er geen vocht de paal binnen.

F: Quand le béton est sec, on peut procéder au serrage.
Nous vous recommandons cependant de laisser de l'espace
entre le poteau et le terrain.
De cette façon, l'humidité ne remontera pas dans le poteau.

N: Når betongen er tørr, kan det lukkes igjen.
Vi anbefaler imidlertid at det er litt luft mellom stolpen og
bakken.
Slik at fuktigheten ikke trenger opp i stolpen.

B

16402-1

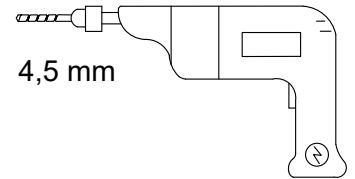
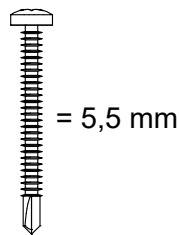
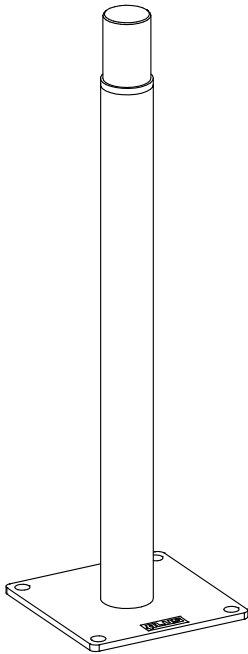

+

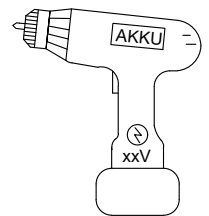
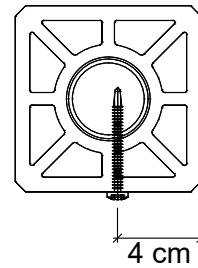

DK: Fastgør stolpen, forbores stille og roligt.

UK: Fix the post, pre-drill carefully.

DE: Befestigen Sie den Pfosten, Vorbohren vorsichtig und langsam.

S: Fäst plinten, förborra lugnt och försiktigt.

FIN: Kiinnitä tolppa, poraa reiät rauhallisesti.

NL: Bevestig de paal, wordt kalm en rustig voorgeboord.

F: Fixer le poteau, pré-percer soigneusement.

N: Fest stolpen, forbores stille og rolig.

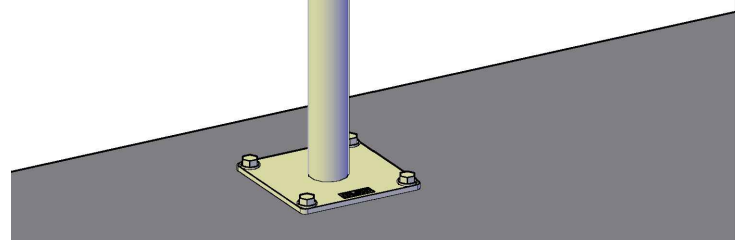
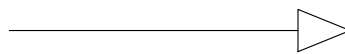
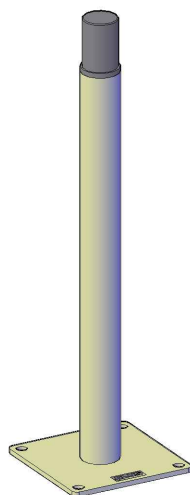
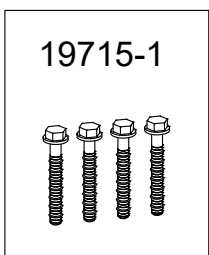
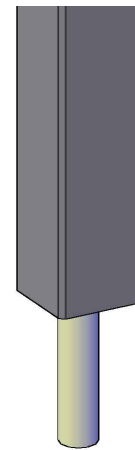

1.

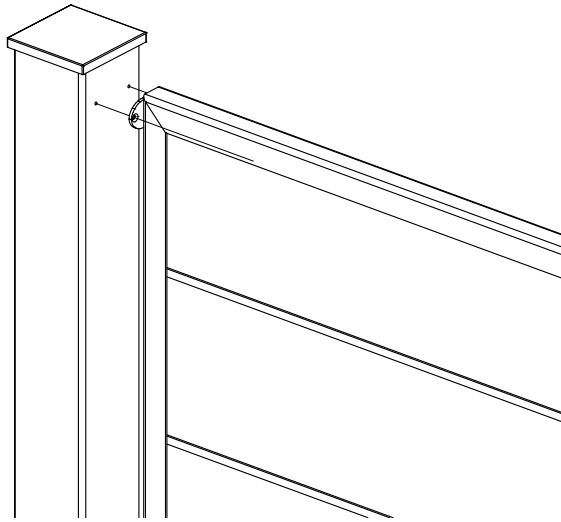

DK: Afmærk på stolpen, hvor hegnet skal monteres.

UK: Mark the post where the fence must be mounted.

DE: Am Pfosten markieren wo der Zaun (Beschlage) montiert werden soll.

S: Markera stolpa dar staketet maste monteras.

FIN: Merkitse tolppaan, mihin kohtaan kiinnike asennetaan.

NL: Markeer de paal waar het hek moet worden gemonteerd.

F: Marquer l'endroit ou la barriere doit ˆtre montee!

N: Merk innlegget der gjerdet skal monteres.

2.

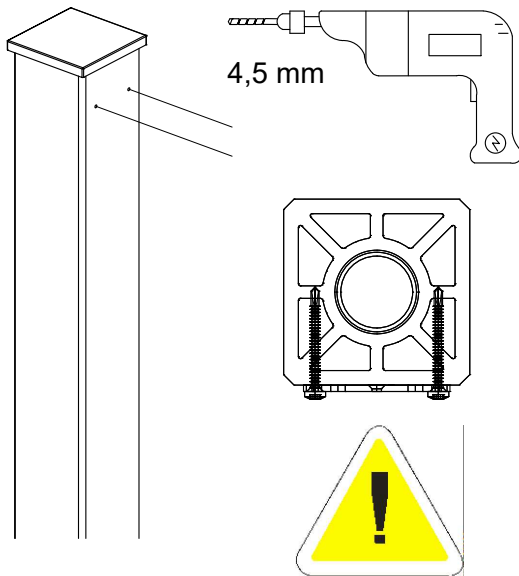

DK: Forbores 4,5 mm

UK: Predrilled 4,5 mm

DE: Vorbohren 4,5 mm

S: Forborra 4,5 mm

FIN: Pora 4,5 mm

NL: Voorboren 4,5 mm

F: Pre-forage 4,5 mm

N: Forbores 4,5 mm

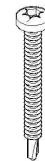

= 5,5 x 50 mm



3.

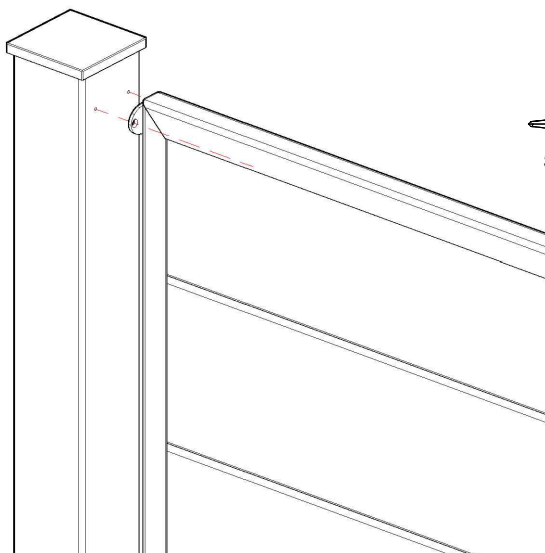

5,5 mm

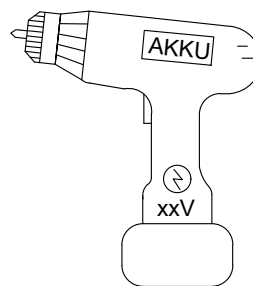

1.

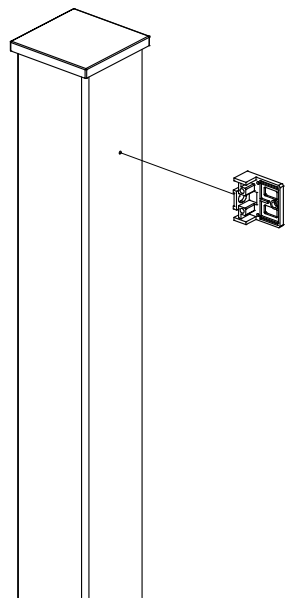

- DK: Afmærk på stolpen, hvor hegnet skal monteres.
- UK: Mark the post where the fence must be mounted.
- DE: Am Pfosten markieren wo der Zaun (Beschlage) montiert werden soll.
- S: Markera stolpa dar staketet maste monteras.
- FIN: Merkitse tolppaan, mihin kohtaan kiinnike asennetaan.
- NL: Markeer de paal waar het hek moet worden gemonteerd.
- F: Marquer l'endroit ou la barriere doit ˆtre montee!
- N: Merk innlegget der gjerdet skal monteres.

2.

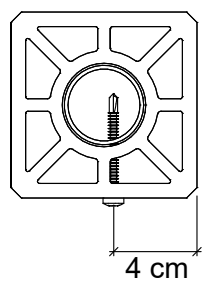
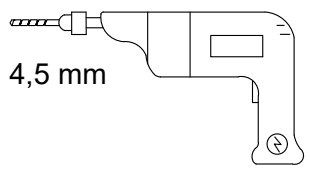
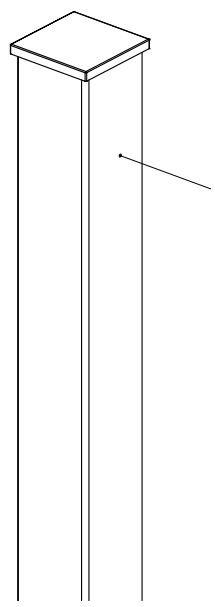

- DK: Forbores 4,5 mm
- UK: Predrilled 4,5 mm
- DE: Vorbohren 4,5 mm
- S: Forborra 4,5 mm
- FIN: Pora 4,5 mm
- NL: Voorboren 4,5 mm
- F: Pre-forage 4,5 mm
- N: Forbores 4,5 mm



= 5,5 x 50 mm

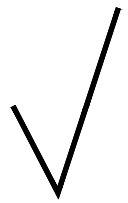
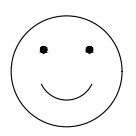

3.

